

**SLIDE GLIDE**

*The Pocket Door Store*



Showrooms

Cork . Dublin. Limerick.

---

[www.slideglide.ie/the-pocket-door-store](http://www.slideglide.ie/the-pocket-door-store)

Pocket Doors & Room Dividing Systems

## Welcome to Our Brochure

The Pocket Door Store is a Section of Slide Glide that specifically deals with the Suppling of Pocket Door Systems and Running Gear for Room Dividers, All Manufactured to the highest of standards which has helped us establish a reputation for excellence among countless companies and interior designers through out Ireland. The possibilities of our sliding Systems are endless, Here in this brochure is only a small selection of what we provide, For more information we advise you to visit our website [www.slideglide.ie/thepocketdoorstore](http://www.slideglide.ie/thepocketdoorstore) where you will see a selection of the different Products and systems that we provide.



## CONTENTS .....PAGES

- Why Pocket Doors..... 3
- Which System ..... 3
- (a) Pocket Frames ..... 4 - 7
- (b) Top Hanging systems .... 8 - 13
- (c) Bottom Rolling systems ..... 14
- Room Dividing Doors ..... 15
- Door Styles ..... 16
- Colours Choice ..... 17
- Service & Recomendations ..... 18



## Why Pocket Doors

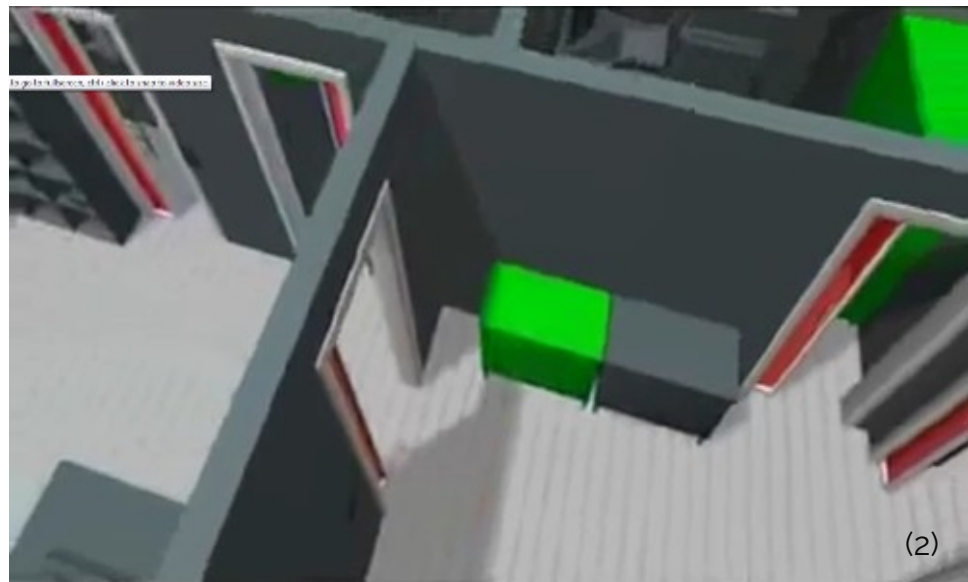
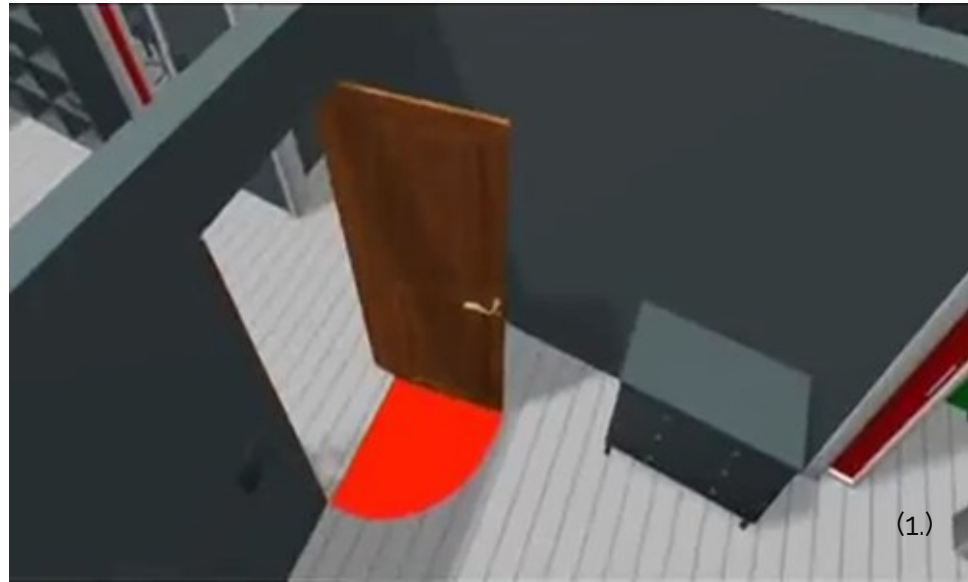

### **SLIDE GLIDE**

**The Pocket Door Store**

Have you ever thought how much space hinged doors waste especially in confined areas e.g. Ensuites, Bathrooms, Utility rooms and hallways, Now think about a Sliding pocket door disappearing into the wall, wasting zero space !

(1.)  
Hinged doors Showing space wasted

(2.)  
Sliding doors Showing space Gained

## Which Sliding System

Before you start Looking and choosing your system you need to distinguish what type of system you require and which suits your situation best.

### (a) Pocket Frames

A Sliding Pocket frame System With Wall Components is a complete kit of components consisting of steel or aluminium vertical uprights, connected to an upper sliding track system from which your chosen door is suspended from which then slides within this structural Framework, This framework is slabbed over with a standard gypsum board and concealed. An overall complete wall thickness of either 100mm or 125mm is achieved even with a standard 45mm door thickness.

### (b) Top Hanging Sliding system

A Sliding Top Hanging System Without Wall Components is a an upper sliding track system from which your chosen door is suspended from. The door is guided in place at the bottom by a bearing wheel, which is screwed to the floor, wheel face up , the bottom of your door is to be rebated and an alloy channel inserted to receive this bearing wheel. ( Can be left Exposed or concealed within a pocket )

### (c) Bottom Rolling Sliding System

A Sliding Bottom Rolling System with base Track this system is different to the others with having a base track, ( This system suitable only as an exposed Solution for it may prove difficult to clean the base track afterwards, if installed within in a Pocket )

All The Systems we provide are highly engineered robust and durable, undergo vigorous testing and are renowned worldwide for been the very best there is.

Pocket Frame



Top Hanging Sliding system

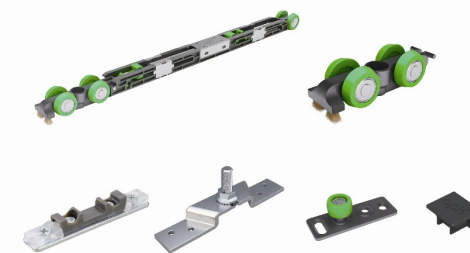

Bottom Rolling Sliding System

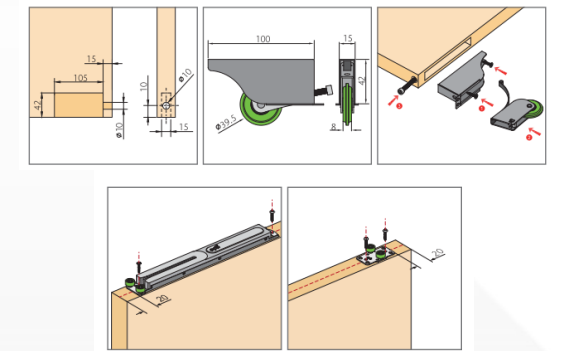

## (a) Pocket Frames

The Promani Pocket system is an extremely robust and high quality pocket system with the added advantages that the system can be adapted directly to the final size of the Sliding door in width and in height.

High-quality carriages with ball-bearing plastic rollers move in elegant aluminium profiles EV1, which guarantee a light, wear-resistant and quiet running. Moving parts are protected from dirt by a self-cleaning construction. The assembly is simple, fast and efficient.

The Track has been especially designed to be easily removed even when the sliding door system is fully installed. In this way, it is possible to add accessories even if the product is already in place, without damaging the wall finishing.

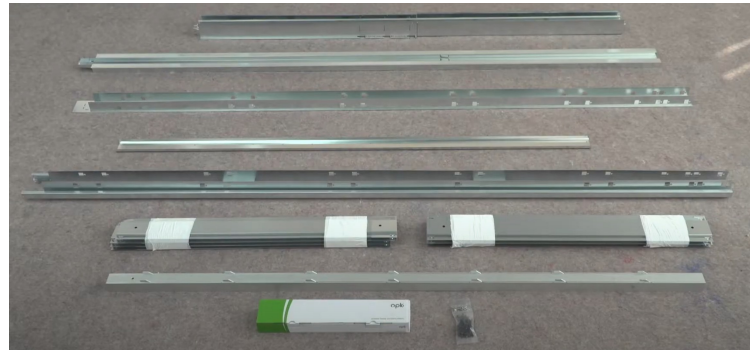

## (6.) Simplicity and Innovation



### ONE POCKET, MANY DIMENSIONS

Promani frames simplify the standard procedure of installing a sliding door pocket system. In fact, during the installation phase, our kits can be adapted directly to the final size of the sliding door.



### STANDARD DOUBLE-SIDED DAMPING SYSTEM INCLUDED

Unlike other products already on the market, Promani offers a two-way damping system of the sliding door always included inside the kit as standard equipment. According to the company philosophy, it is important to offer our customers a complete product for the best user experience.



### EXTRACTABLE TRACK

The track has been especially designed to be easily removed even when the sliding door system is fully installed. In this way, it is possible to add accessories even if the product is already in place, without damaging the wall finishings.



### DRYWALL U PROFILES

The U shape on the outer perimeter of the frame allows the direct installation of the C profiles to complete the plaster board structure of the wall. This solution makes it possible to improve and to accelerate the installation process of the pocket without using additional U profiles.

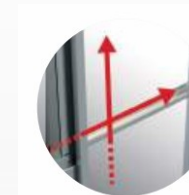

### SPACER PROFILE

The spacer profile included in the Promani Door Frame Kit allows a perfectly aligned installation to the plasterboard structure, avoiding accidental mistakes that sometimes happens in drywall construction.



Sliding pocket door ENTIRELY MADE OF ZINC-COATED STEEL,



**SLIDE GLIDE**

The Pocket Door Store

ONE is the pocket system for sliding doors that unifies tradition and innovation. The frame is completely made of zinc-coated steel and has to be completed with jambs and architraves. Thanks to its characteristics, the sliding door frame ONE fits into any door measure and represents a practical solution. It guarantees a comfortable daily use of sliding doors, creating a modern and clean style in internal spaces.

UK610-838ONE DATA SHEET

DW x DH Door dimensions	C x H Frame dimensions	A x H' Opening of the doorway	WT Wall thickness
610 x 1981 mm	1418 x 2086 mm	640 x 2016 mm	100/125 mm
610 x 2040 mm	1418 x 2145 mm	640 x 2075 mm	100/125 mm
686 x 1981 mm	1570 x 2086 mm	716 x 2016 mm	100/125 mm
686 x 2040 mm	1570 x 2145 mm	716 x 2075 mm	100/125 mm
762 x 1981 mm	1722 x 2086 mm	792 x 2016 mm	100/125 mm
762 x 2040 mm	1722 x 2145 mm	792 x 2075 mm	100/125 mm
838 x 1981 mm	1874 x 2086 mm	868 x 2016 mm	100/125 mm
838 x 2040 mm	1874 x 2145 mm	868 x 2075 mm	100/125 mm

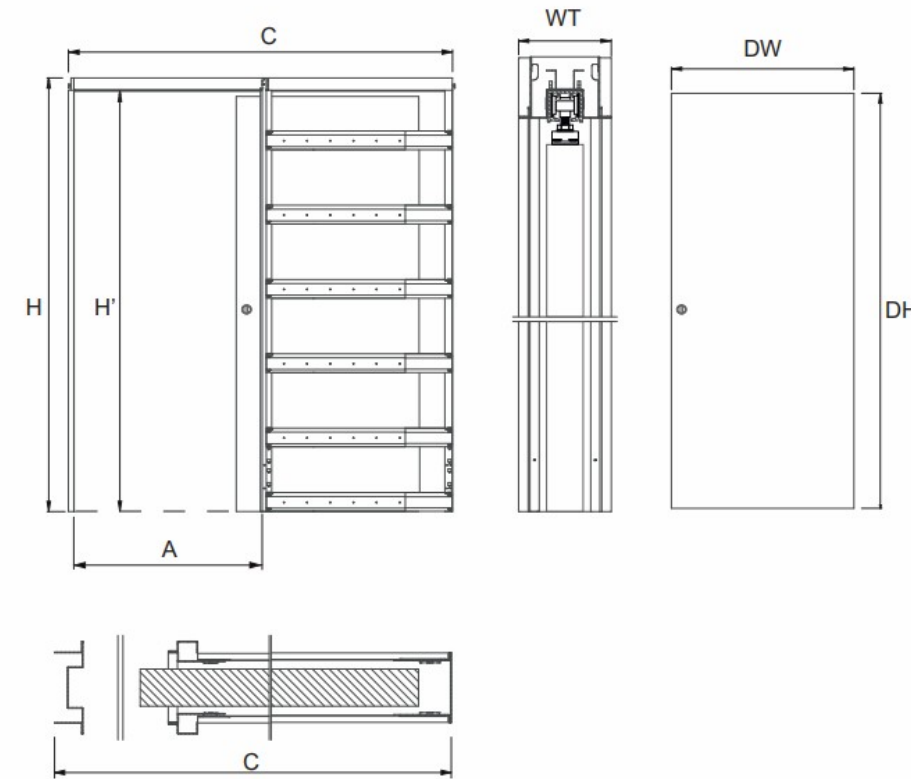

Advantages at a Glance

- Easy removable Track giving access to wheels.
- Standard Double Soft closing damping system included.
- The inside pocket damping position can be adjusted after wall has been installed.
- The upper profile has different marks in order to suit different door widths .
- The Vertical Beams have different marks to suit different height doors and possible to cut accordingly.
- The Crossbeams have Telescopic adjustment to suit different width doors.

## TWIN ONE, Double Door system



TWIN ONE DATA SHEET

DW x DH Door dimension	C x H Frame dimension	C' x H' Width of the doorway	WT Wall thickness
610+610 x 1981 mm	2733 x 2068 mm	1230 x 2016 mm	100/125 mm
610+610 x 2040 mm	2733 x 2145 mm	1230 x 2075 mm	100/125 mm
686+686 x 1981 mm	3037 x 2086 mm	1382 x 2016 mm	100/125 mm
686+686 x 2040 mm	3037 x 2145 mm	1382 x 2075 mm	100/125 mm
762+762 x 1981 mm	3341 x 2086 mm	1534 x 2016 mm	100/125 mm
762+762 x 2040 mm	3341 x 2145 mm	1534 x 2075 mm	100/125 mm
838+838 x 1981 mm	3645 x 2086 mm	1686 x 2016 mm	100/125 mm
838+838 x 2040 mm	3645 x 2145 mm	1686 x 2075 mm	100/125 mm
914+914 x 1981 mm	3949 x 2086 mm	1838 x 2016 mm	100/125 mm
914+914 x 2040 mm	3949 x 2145 mm	1838 x 2075 mm	100/125 mm
815+815 x 2110 mm	3343 x 2215 mm	1640 x 2145 mm	100/125 mm

**SLIDE GLIDE**  
The Pocket Door Store

Thanks to TWIN you can join 2 ONE pockets and get a double concealed sliding door system. Using a simple template and specific pins, the coupling of two pockets is easy and error-free. For greater openings, with very short assembly times.

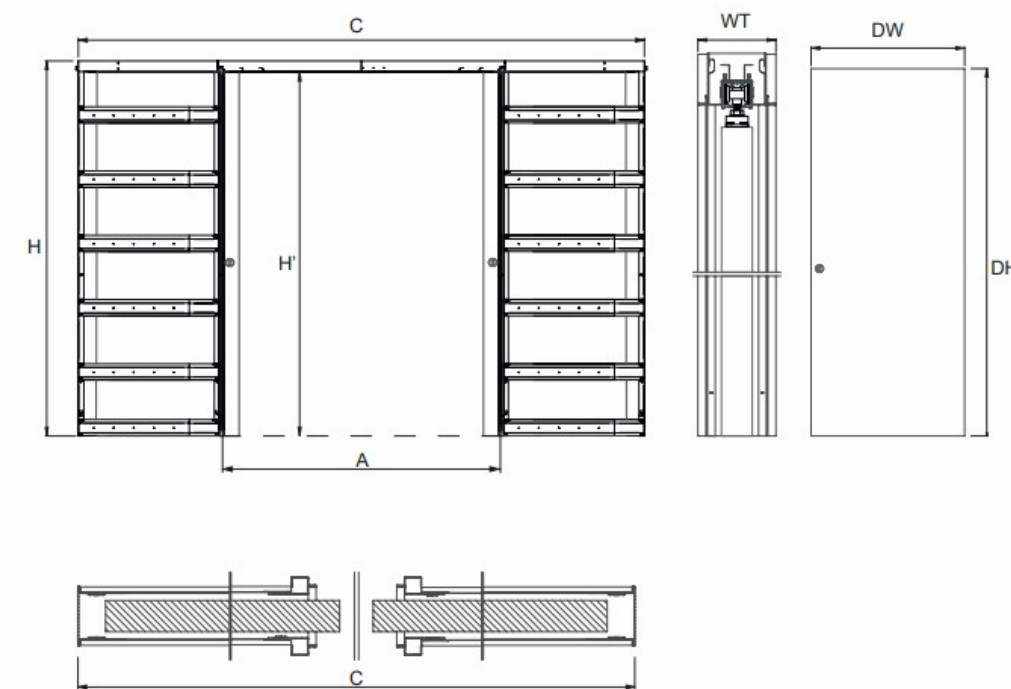



## The Giant ONE,

The ONE the pocket system is available to suit extra wide doors and also extra high doors. The Giant one consists of an extra kit which is added to the standard system which will increase the system to suit a door height up to 2760mm.



**SLIDE GLIDE**  
The Pocket Door Store



## Extra Wide System Data,

DW x DH Türblattmaße	C x H Elementmaße	A x H' Rohdurchgangsmaße	WT Fertige Wandstärke
1110 x 1985 mm	2319 x 2085 mm	1140 x 2015 mm	100/125 mm
1110 x 2110 mm	2319 x 2210 mm	1140 x 2140 mm	100/125 mm
1235 x 1985 mm	2569 x 2085 mm	1265 x 2015 mm	100/125 mm
1235 x 2110 mm	2569 x 2210 mm	1265 x 2140 mm	100/125 mm

## Extra High System Data,

DH Türgröße	H Elementgröße	H' Durchgangsbreite	WT Fertige Wandstärke
2210 mm	2310 mm	2240 mm	100/125 mm
2260 mm	2360 mm	2290 mm	100/125 mm
2310 mm	2410 mm	2340 mm	100/125 mm
2360 mm	2460 mm	2390 mm	100/125 mm
2410 mm	2510 mm	2440 mm	100/125 mm
2460 mm	2560 mm	2490 mm	100/125 mm
2510 mm	2610 mm	2540 mm	100/125 mm
2560 mm	2660 mm	2590 mm	100/125 mm
2610 mm	2710 mm	2640 mm	100/125 mm
2660 mm	2760 mm	2690 mm	100/125 mm
2710 mm	2810 mm	2740 mm	100/125 mm
2760 mm	2860 mm	2790 mm	100/125 mm

(b) Top Hanging sliding systems

The possibilities of our sliding systems are unlimited, be it overlapping the wall and left as an exposed system or concealed within a wall, referred to as a Pocket system, the choice is yours. See from below Solutions to closing off any opening with sliding doors. High-quality carriages with ball-bearing plastic rollers move in elegant aluminium profiles EV1, which guarantee a light, wear-resistant and quiet running. The assembly is simple, fast and efficient.

Single Door System,



Double Door System, Each Way



Telescopic Double Door System, One Way



Telescopic Triple Door System, One Way



**SLIDE GLIDE**

The Pocket Door Store

Telescopic Systems,

The Telescopic Systems will enable an opening be covered either by two or three doors which slide to the one side. Open the leading door and the others will follow, Functional and Practical. Available with and without soft close.

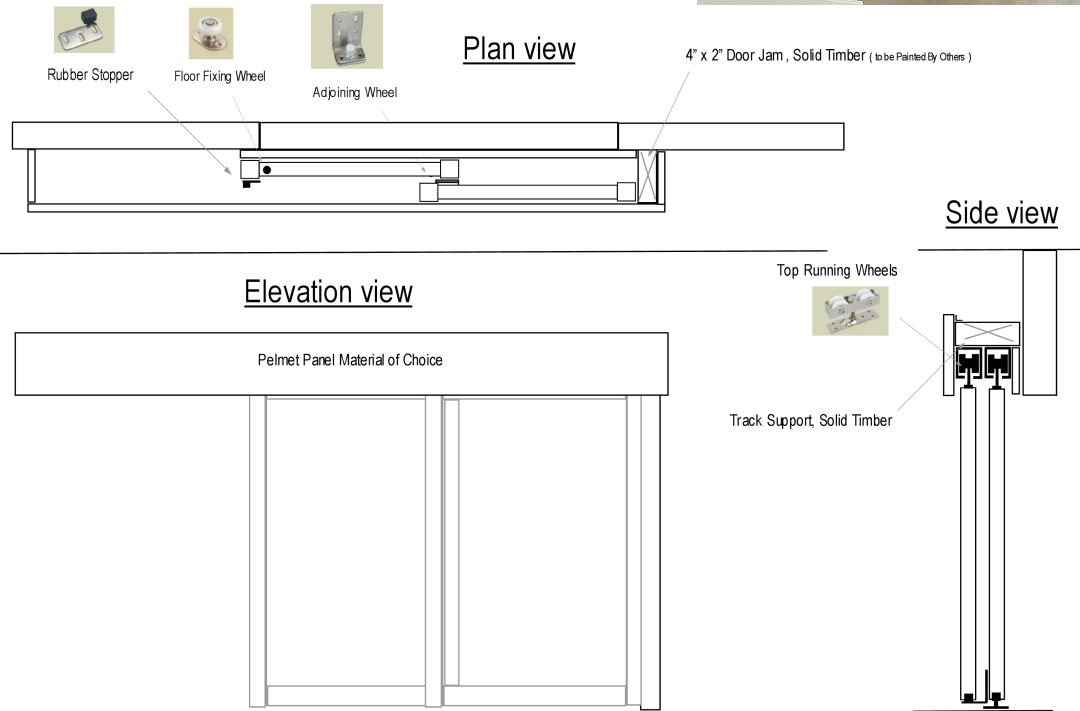



## (b) Top Hanging system

This is a an upper sliding track system from which your chosen door is suspended from. The door is guided in place at the bottom by a bearing wheel, which is screwed to the floor (wheel face up) , the bottom of your door is to be rebated and an alloy channel inserted in to this channel to receive the bearing wheel. All these systems can be concealed behind a wall becoming a pocket system or left exposed which we simply refer to as an exposed system. Doors of your own choice can be suspended from any of our systems either a solid door matching your existing Doors (purchased elsewhere) or we can also supply made to measure Profiled doors, to view go to <https://slideglide.ie/room-dividing-doors/>

There are numerous Wheel and Track Sets that we Provide with and without Soft close. Ceiling Mounted or Wall Mounted. Below Examples are Wall Mounted and Capped with a Pelmet.



### Single Overlay top Hanging system

Premium Bearing , Alloy , steel , Nylon  
Finish : Nickel  
Weight Capacity : 80Kgs / Ea. Door

## TW08 to Suit Wood and Profiled Doors,

High-quality carriages with ball-bearing plastic rollers move in elegant aluminium profiles EV1, which guarantee a light, wear-resistant and quiet running. The assembly is simple, fast and efficient. Plastic stopper no Soft Closing



## TW10 to Suit Wood and Profiled Doors,

High-quality carriages with ball-bearing plastic rollers move in elegant aluminium profiles EV1, which guarantee a light, wear-resistant and quiet running. The assembly is simple, fast and efficient. Tension Adjustable Rubber Stopper Steel robust Construction



## TW12 Spaceship to suit Wood and Profiled Doors,

Its technically advanced system makes OPK Spaceship suitable for ceiling mounted applications. High-quality carriages with ball-bearing plastic rollers move in elegant aluminium profiles EV1, which guarantee a light, wear-resistant and quiet running. Moving parts are protected from dirt by a self-cleaning construction. The assembly is simple, fast and efficient. Hydraulic Soft closing Two Way



TW12 WMT to suit Wood and Profiled Doors, ( Wall Mounted Track)

High-quality carriages with ball-bearing plastic rollers move in elegant aluminium profiles EV1, which guarantee a light, wear-resistant and quiet running. Moving parts are protected from dirt by a self-cleaning construction. The assembly is simple, fast and efficient. Track is Designed for Easy installation with Pre Drilled Holes. and Grooved to take Specially designed Clip on Capping Pelmet.

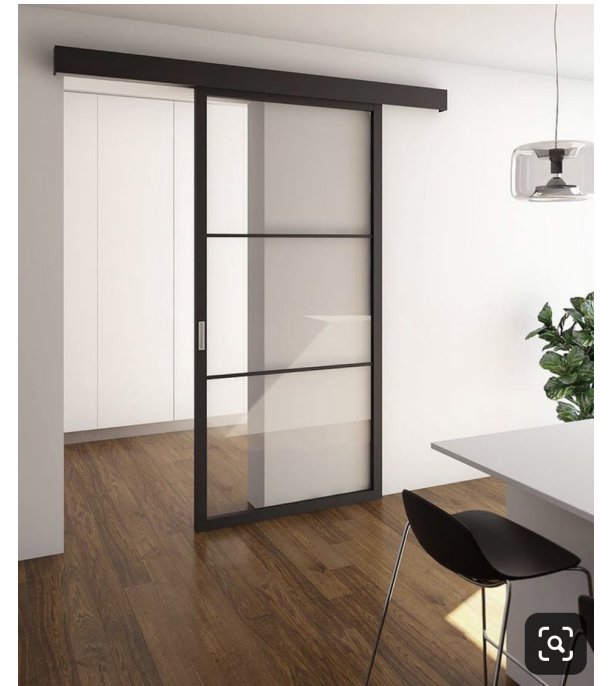
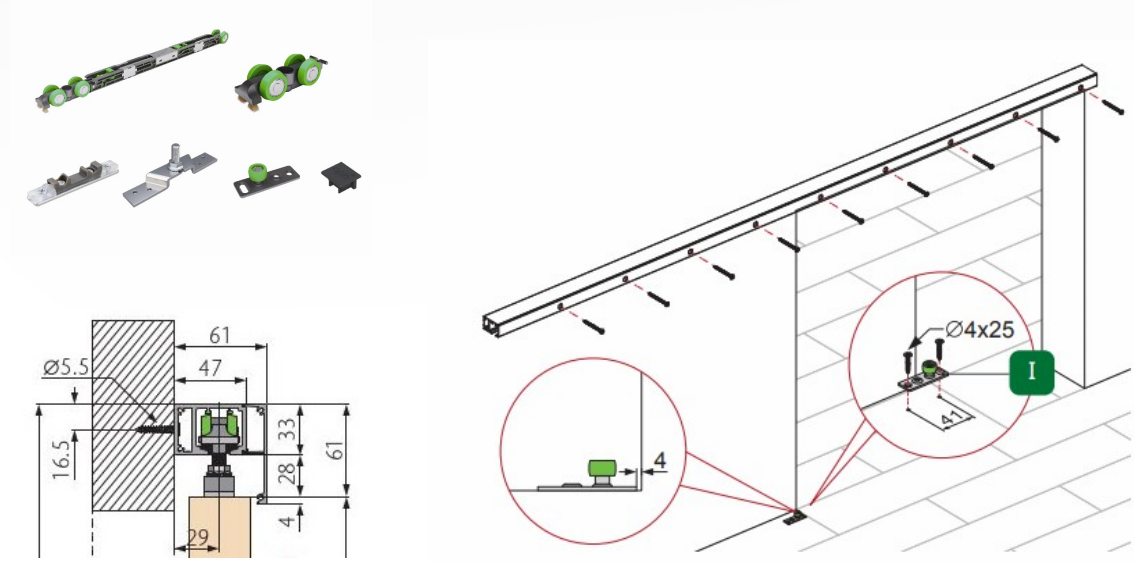

TW12 M. (Minimal hanging system ) to Suit Wood Doors,

Same Wheel Sets as TW12 except the hanging bracket are different , with this system the top of the door needs to be rebated so fixings are hidden within the door allowing the door to hang approximately 8mm from the track. ( known as Minimal Fixing )

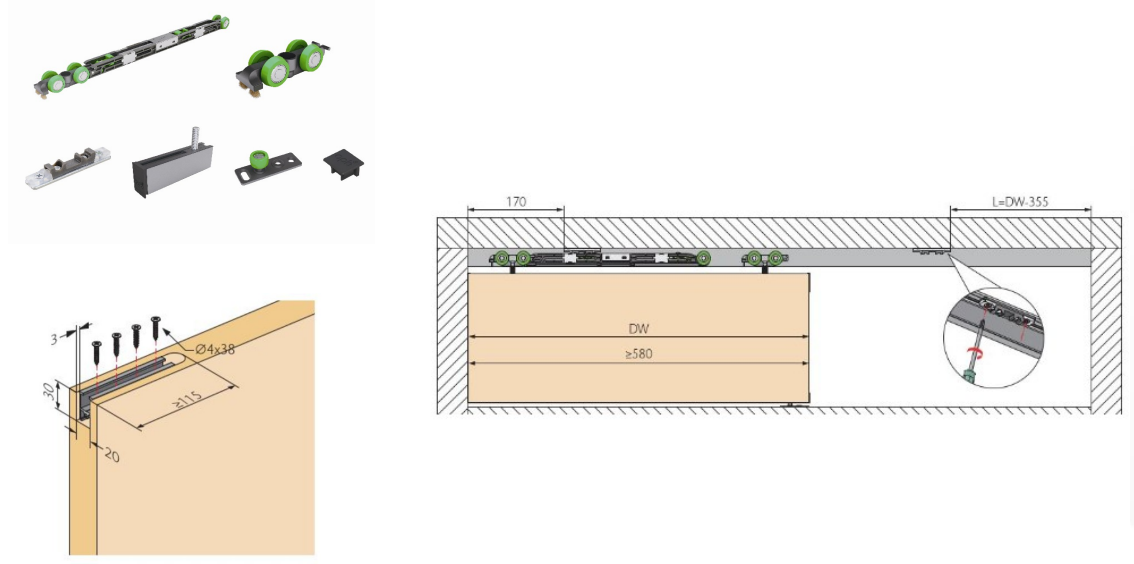

Silver Aluminium Capping Pelmet with Finished ends Available to go with Wall Mounted Track, Black and other Colours available as a Laminated Panel

Floor to Ceiling Panel , Track recessed into Ceiling , Minimal Hanging system allowing Panel to hang within millimetres of the Track



TW12 M 2PT. ( Minimal Hanging system ) Wood Two Part Track.



The Two Part Track system is an extremely innovative and clever method, which allows you to be able to remove the track and wheels very easily, if there was ever a need to do so.

How this works is a Receiver Channel which has inset slots is installed firstly and the main Roller track which has brackets on its top side clips into the receiver slots.

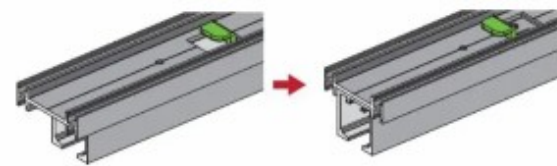
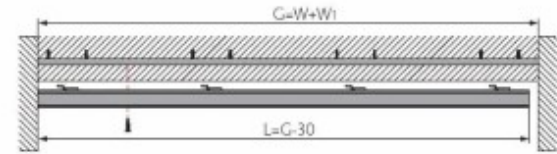

Navigator 3 Wall Mounted Track



With its various design solutions, the model OPK Navigator 3 is in the current trend with striking and visible (sliding) fittings. Finished in Black Cast Iron Look. The plastic rollers are ball-bearing construction, this guarantees a light, wear-resistant and quiet running. The assembly is simple, fast and efficient.





### TW14 G. Spaceship For Glass

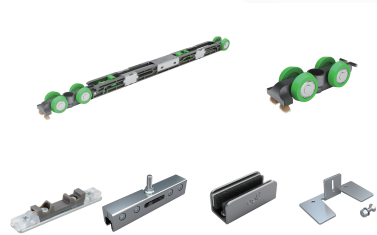

Its technically advanced system makes OPK Spaceship suitable for ceiling, wall and pocket applications. High-quality carriages with ball-bearing plastic rollers move in elegant aluminium profiles EV1, which guarantee a light, wear-resistant and quiet running. Moving parts are protected from dirt by a self-cleaning construction. The assembly is simple, fast and efficient.



**SLIDE GLIDE**  
The Pocket Door Store

Wall Mounted or Ceiling Mounted Adaptable to every situation. Providing Confidence that your door will slide smooth and effortlessly for many years to come.





## OPK E - Space

OPK E-Space is an automated sliding door system for interior fittings.

The innovative magnetic drive opens up completely new application possibilities with OPK E-Space. Barrier-free access with maximum convenience is created. It can be operated as a single or synchro system. The magnetic drive moves in slim aluminium profiles with ball-bearing plastic rollers, which guarantee smooth, quiet and practically maintenance-free run. The entire assembly is simple, quick and immediately ready for operation. A plug-in delivery and commissioning by plug & play are characteristic of this. The doors can already be controlled via app (iOS + Android) or touch as standard. The app offers the possibility of user-friendly and individual settings. The system also offers multifunctional connectivity options.



Certification by TÜV Rheinland and SGS guarantee maximum security. This includes, among other things, that the doors can be moved without problems despite a power failure, that there is no risk of being crushed due to low-energy operation and that the magnetic field used is harmless to health.

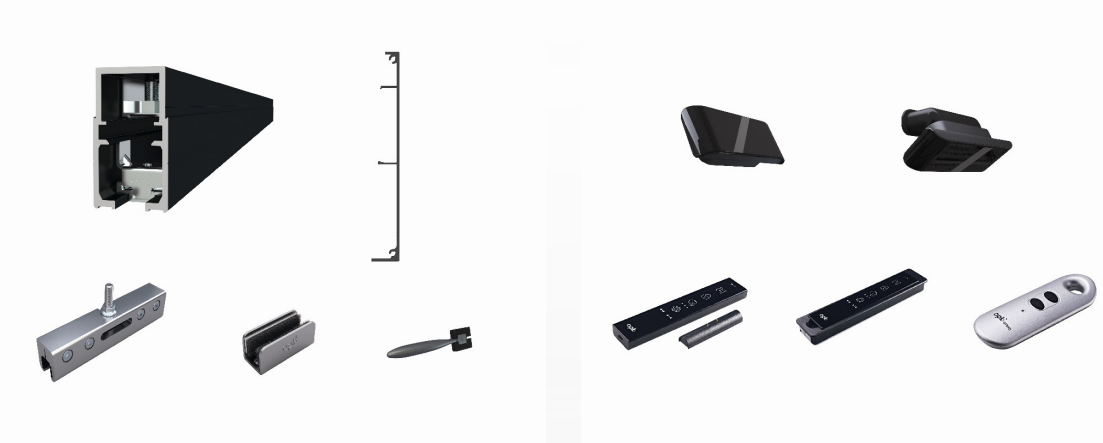

**SLIDE GLIDE**  
The Pocket Door Store

### The advantages at a glance

- A universal door connection for glass and Timber doors.
- Simple, quick installation, height adjustment +/- 3 mm
- Door leaf weight up to 100 kg
- Door widths from 750 mm
- As a single system, track lengths from 1.400 to 3.400 mm
- As a synchro system, track lengths from 2.800 to 6.800 mm
- Mobile App control ,  
Sensor Control or Touch Control

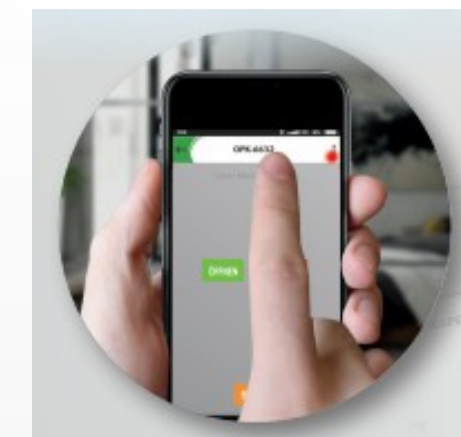



(c) Bottom Rolling Room Dividing System

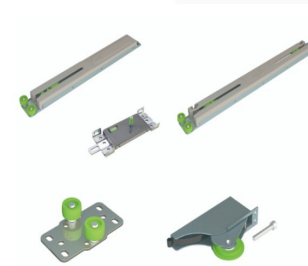

OPK Cruiser Wood Bottom Rolling is a room-dividing and Wardrobe Door system that can be used to create a versatile room utilisation concept.

The bottom-running system is designed for wooden doors up to 50 kg per door. Available in double and single running tracks for Floor mounting open up new interior architectures.

Excellent running and damping properties ensure a high-quality user experience.

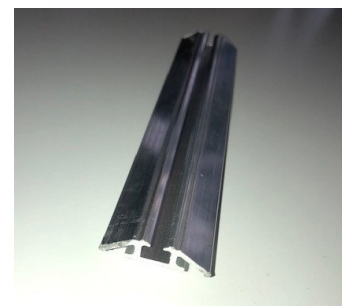
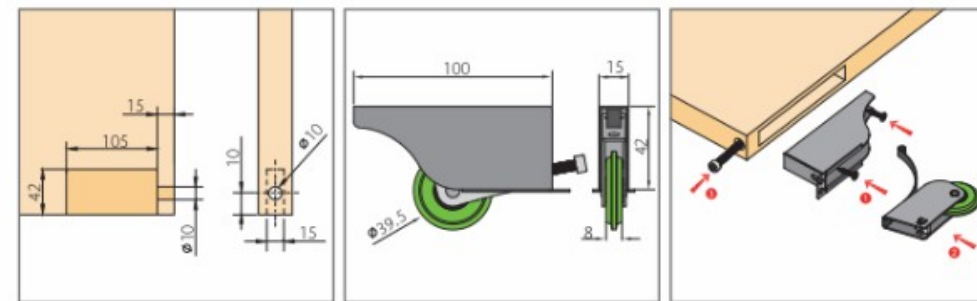
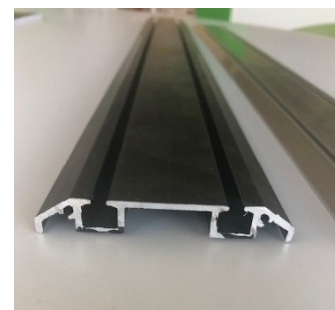
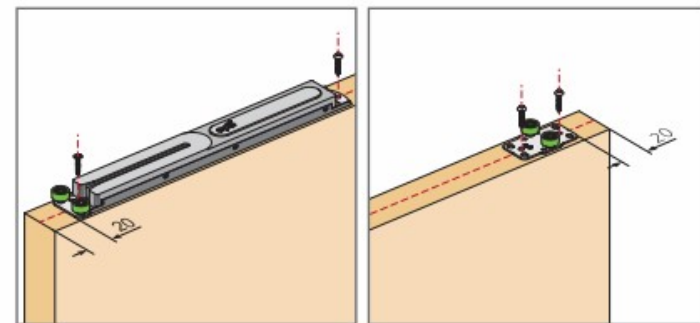

**SLIDE GLIDE**  
The Pocket Door Store

The advantages at a glance

- Bottom Rolling 6mm high low Profile base Track
- Simple, quick installation, height adjustment +/- 10 mm
- Door leaf weight up to 50 kg
- Wooden doors, height up to 2800 mm, width from 600 mm, thickness 25-32 mm
- Carriages with ball-bearing plastic rollers ensure extremely light and quiet running
- Anti-Jump function



### Room Dividers. Door Choice.

Our Made To Measure Room Dividing Doors are adaptable to almost any situation or Function Private Residence or commercial and available in a large selection of colours, Designs and Styles, Firstly Select which Slide system that Suits your needs and then choose your door Style.



**SLIDE GLIDE**  
The Pocket Door Store

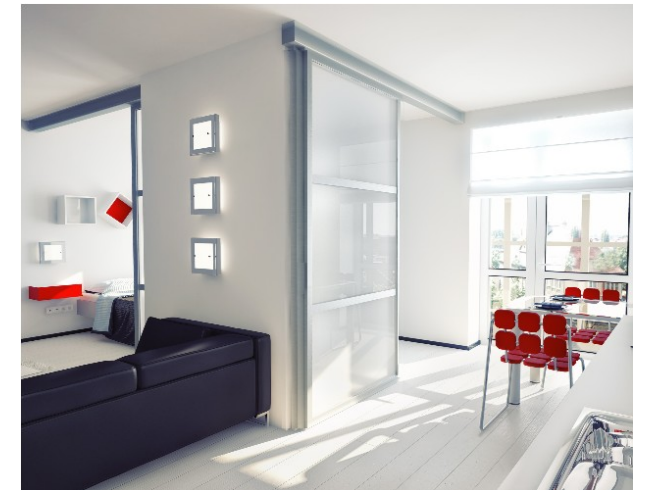



Advantages at a Glance

- \* Made to measure
- \* Adaptable to Angles and Irregular wall shapes
- \* Highest Quality Components
- \* Anti Jump Sealed Bearing wheels (Increased Safety)
- \* 18mm thickness Door Panels ( Increased rigidity no warping ! )
- \* All Glass incased within a gasket surround & Glass toughened
- \* Door Positioner as standard , Hydraulic softclose optional
- \* Rubber cushion Rebated within vertical profile ( not glued )

Steps to designing your Doors.

1. Select Door Style e.g. Full Panel or split Panel
2. Select Profile Colour e.g. Profileless, Silver , Champagne, Cream, White , Black, Walnut , Oak
3. Select Panel Element & Colour e.g. Clear or Satinized Glass, MFC , MDF or Mirror.

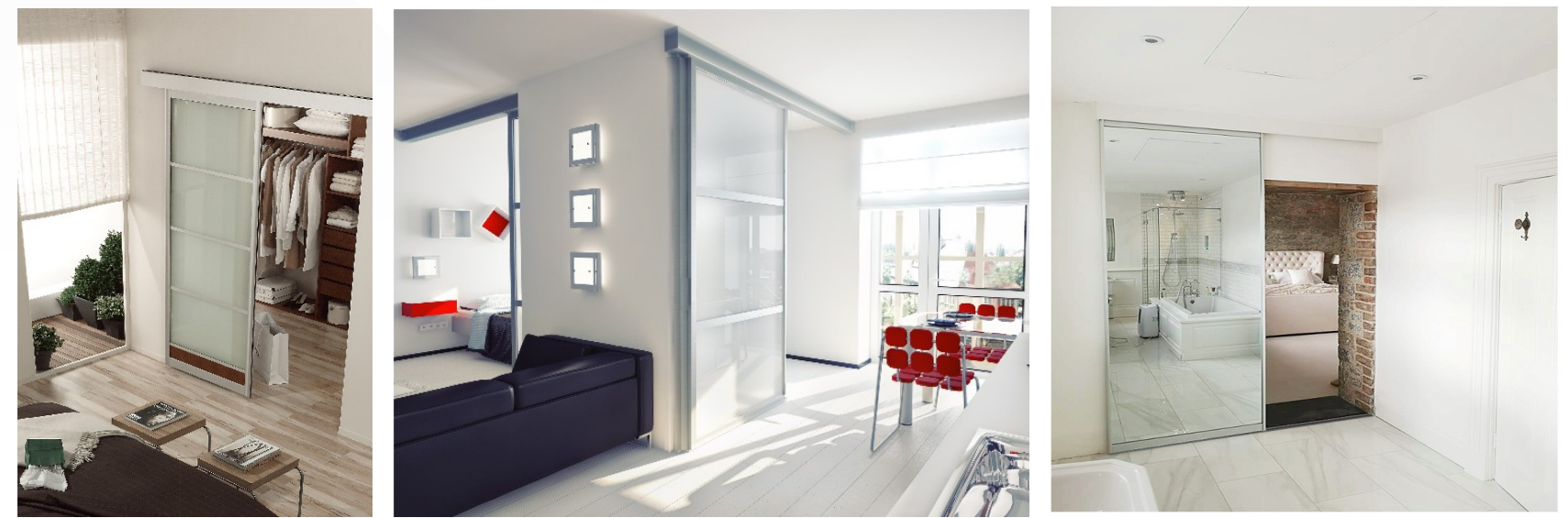
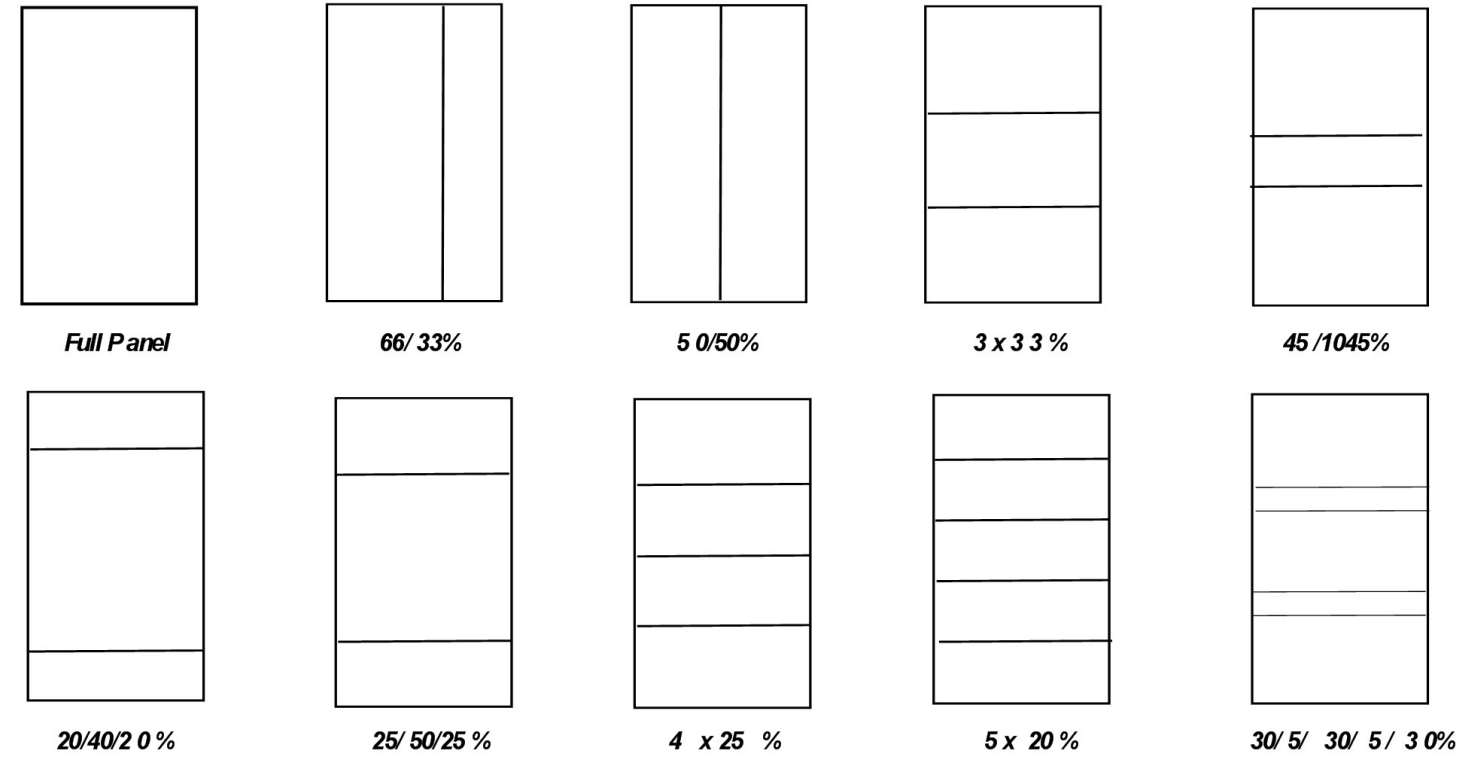



### Door Profiles

Selecting the door profile is an important decision in the overall look and design, the choice is to either contrast the profile with the inset panels of your doors or to match and blend, the choice is yours.

Our profiles are constructed from 2mm Extruded aluminium and are of the wider 18mm design increasing the overall rigidity of the doors. The vertical handle profiles are rebated for rubber cushion reducing slamming on closing.

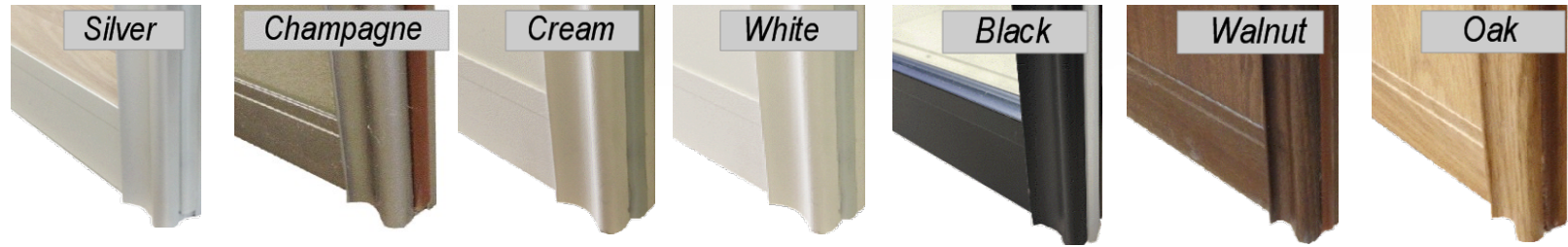

### MFC for Door Panels



### MDF Acrylic High Gloss for Door Panels

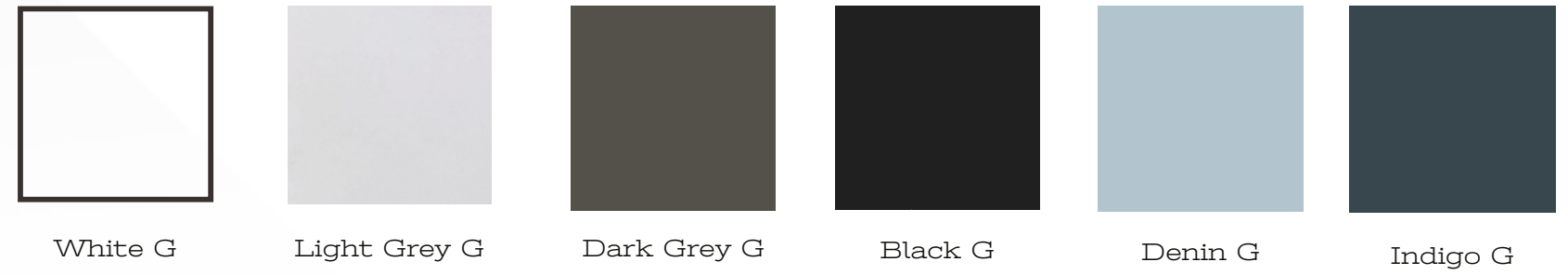

### MDF Super Matt for Door Panels

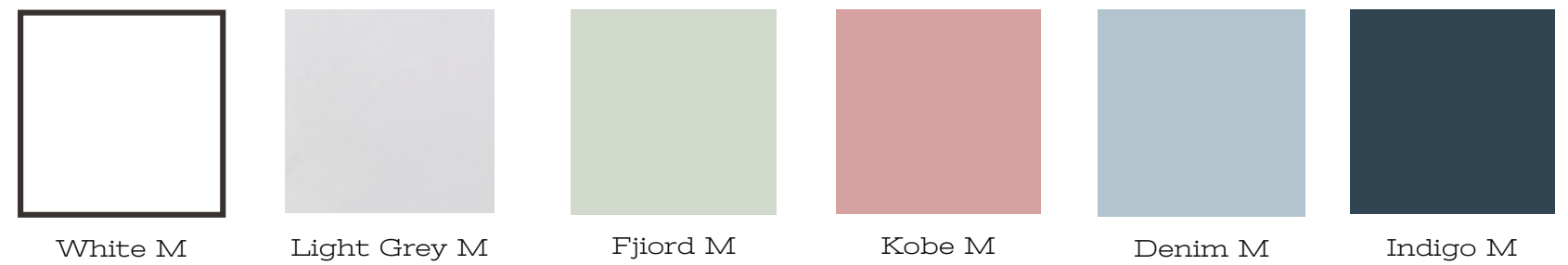

### Mirrors and Glass for Door Panels



### MFC Abstract



## The Service

### Designed for you

Creating your perfect room is not just our job, it's our passion. We always encourage on any potential customer to visit any of our showrooms firstly where it is here you can really see and more importantly feel how smooth and robust our sliding doors are. We believe it is this what separates our product from others,

### Made for you

Before we manufacture your project, every little last detail is double checked in your home survey, the angle of the slope of that ceiling an uneven floor or ceiling is all accounted for , Only then it is made to order at our factory using our highly advanced computerised millimeter perfect machinery.

### Installed for you

At Slide Glide, our skilled joiners and craftsmen are dedicated to doing the best job possible for you. When they come to fit your project, they'll do it with care, precision and attention to detail, Leaving you with a perfect job and a dream finish.

### Supply Only, Optional Service

For those who are not local to our showrooms and who may be Confident and able to install themselves we can also offer any of our products on a Self install basis, just go to our website and select what it is you are interested in, Maybe you want to cover an existing robe with our Sliding doors , Divide up a large room with room dividers, what ever it may be, will gladly help.

### Our Gurantee

At Slide Glide, we're so confident in its our Doors durability and functionality we provide a 10 year product guarantee against manufacturing defects, at the end of the day, we don't just want you to be happy now – but for many years to come.



## What our clients have said

With over twenty years of past customers and thousands of projects completed, it is in our best interests we get it right every time . Please feel free to go to google or Facebook and see genuine customer feedback.



**Ashling M**

5 reviews · 5 photos

★★★★★ 3 months ago

I was looking all over the internet for a customised sliding/pocket or hanging door to partition my kitchen from my living room. I just couldn't see anything really suitable where I could see exactly what I was getting. Thankfully I came ... [More](#)

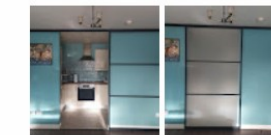

**Liam Twomey**

1 review

★★★★★ 3 years ago

Hi , the experience of dealing with Slide Glide was a pleasure from start to finish . Everything they said they'd do they did, from the initial planning to the first on site consult and then the installation, excellent. Thanks

👍 Like



**Liam**

7 reviews · 7 photos

★★★★★ a year ago

Had an amazing work done by this company, I can not recommend them highly enough. Everything went without a problem, arrived when they said and did exactly what they said they'd do to a very high standard. Thanks very much

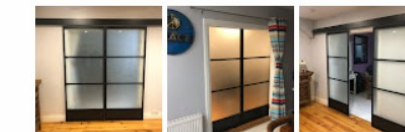

**Deirdre Faulkner**

6 reviews

★★★★★ a year ago

The guys arrived @10:30 got stuck straight into it, done an amazing job , absolutely beautiful. No mess left.