

# opk SPACESHIP 80

Synchro W Minimal

FÜR DIE KLEINEN DINGE. MIT GROSSER WIRKUNG.  
FOR THE LITTLE THINGS. WITH A BIG EFFECT.  
POUR LES PETITES CHOSES. AVEC UN GRAND EFFET.

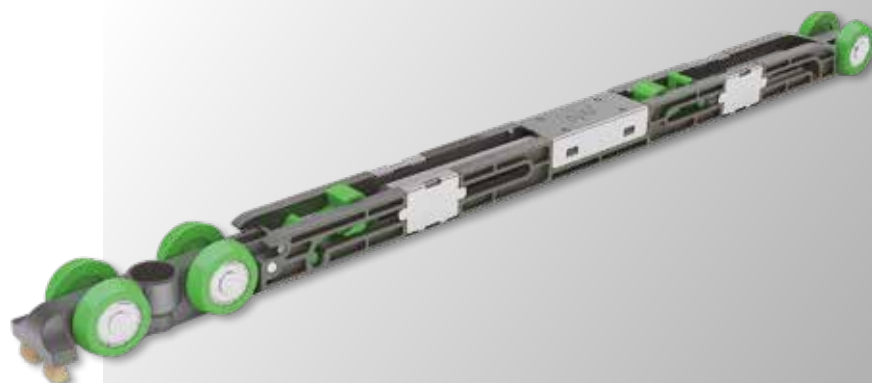
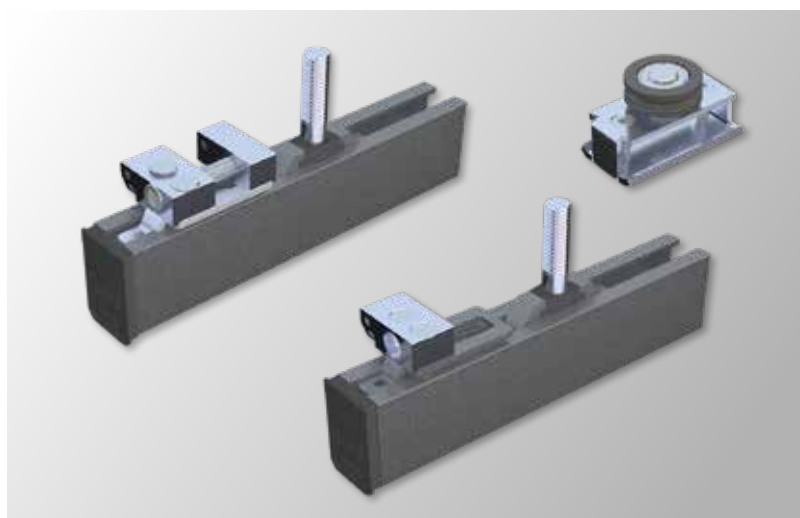
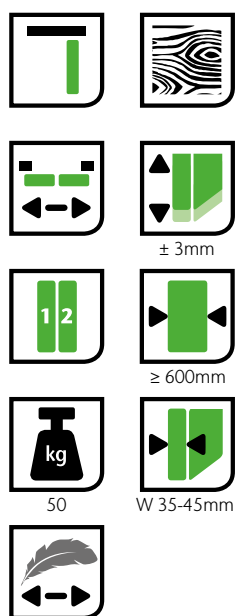

# opk Spaceship 80 Synchro W Minimal



## Technische Zeichnung Technical drawing / Plans et schémas

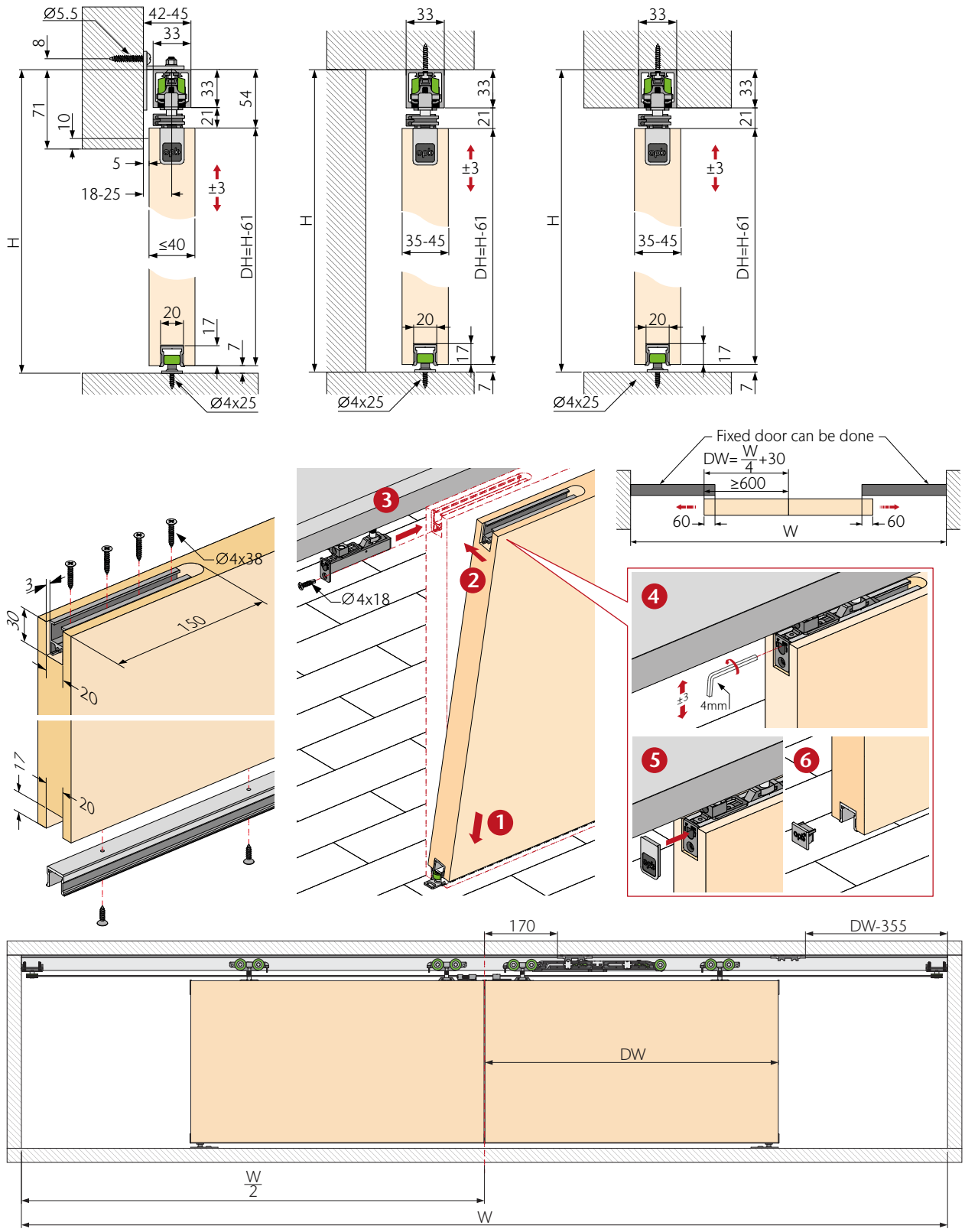

# opk Spaceship 80 Synchro W Minimal



## Deckenmontage

Ceiling Mounting / Montage au plafond



Art.-Nr./No./N° d'art.

		≤50	≤600	03-011-200-001
--	--	-----	------	----------------

## Konfiguration für 1 Tür

Configuration for 1 door / Configuration pour 1 porte



<b>Laufwerk mit 2-Wege Dämpfer</b> <i>Running part with two-way damper / Train de roulement avec amortisseur 2 voies</i>		1
<b>Laufwerk</b> <i>Running part (roller) / Train de roulement</i>		3
<b>Aktivator</b> <i>Activator / Activateur</i>		2
<b>Aufhängung Minimal Holz</b> <i>Minimal bracket wood / Suspension Minimal bois</i>		2
<b>Bodenführung 1 Rolle Holz</b> <i>Floor guide 1 roller wood / Guidage au sol 1 rouleau bois</i>		2
<b>Umlenkrolle</b> <i>Winding roller / Rouleau d'enroulement</i>		2
<b>Aufhängung Minimal mit Seilspanner</b> <i>Adjustable Hanging Plate A / Plaque de suspension réglable A</i>		1
<b>Aufhängung Minimal mit Seilführung</b> <i>Adjustable Hanging Plate B / Plaque de suspension réglable B</i>		1
<b>Stahlseil mit Kunststoffummantelung</b> <i>Steel cable with plastic coating / Câble en acier avec revêtement en plastique</i>		1
<b>Endkappe Führungsschiene</b> <i>Cover cap guiding track / Embout rails de guidage</i>		4
<b>Zubehörset Holz Minimal</b> <i>Accessories wood minimal / Set d'accessoires Minimal bois</i>		1

# opk Spaceship 80 W/G









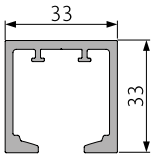

## Wandmontage

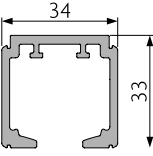
Wall Mounting / Montage mural

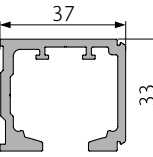
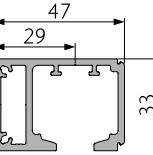

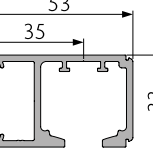
## Schienen, Zubehör

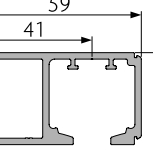
Tracks, Accessories / Rails, Accessoires

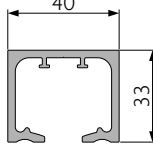
Produktbeschreibung Product description / Description du produit		Material Material / Matériel	Farbe Finish / Couleur	Länge (mm) Length / Longueur	Art.-Nr./No./ N° d'art.
<b>Laufschiene 33mm</b> Running track / Rail de roulement 		<b>Aluminium eloxiert</b> Anodized aluminium Aluminium anodisé	<b>Silber</b> Silver Argent	2050	03-016-252-E20
				2500	03-016-252-E25
				3500	03-016-252-E35
				5800	03-016-252-E58
<b>Laufschiene clip-in Blende 34mm</b> Running track click in cover / Rail de roulement cache à clipser 		<b>Aluminium eloxiert</b> Anodized aluminium Aluminium anodisé	<b>Silber</b> Silver Argent	2050	03-016-252-H20
				2500	03-016-252-H25
				3500	03-016-252-H35
				5800	03-016-252-H58
<b>Laufschiene clip-in Blende 37mm</b> Running track click in cover / Rail de roulement cache à clipser 		<b>Aluminium eloxiert</b> Anodized aluminium Aluminium anodisé	<b>Silber</b> Silver Argent	2500	03-016-251-D25
<b>Laufschiene clip-in Blende 47mm</b> Running track click in cover / Rail de roulement cache à clipser 		<b>Aluminium eloxiert</b> Anodized aluminium Aluminium anodisé	<b>Silber</b> Silver Argent	2050	03-016-251-A20
				2500	03-016-251-A25
				3500	03-016-251-A35
				5800	03-016-251-A58
<b>Laufschiene clip-in Blende 53mm</b> Running track click in cover / Rail de roulement cache à clipser 		<b>Aluminium eloxiert</b> Anodized aluminium Aluminium anodisé	<b>Silber</b> Silver Argent	2050	03-016-251-B20
				2500	03-016-251-B25
				3500	03-016-251-B35
				5800	03-016-251-B58
<b>Laufschiene clip-in Blende 59mm</b> Running track click in cover / Rail de roulement cache à clipser 		<b>Aluminium eloxiert</b> Anodized aluminium Aluminium anodisé	<b>Silber</b> Silver Argent	2050	03-016-251-C20
				2500	03-016-251-C25
				3500	03-016-251-C35
				5800	03-016-251-C58
<b>Laufschiene 40mm</b> Running track 40mm / Rail de roulement 40mm  		<b>Aluminium eloxiert</b> Anodized aluminium Aluminium anodisé	<b>Schwarz</b> Black Noir	2050	03-016-272-I20
				2500	03-016-272-I25
				5800	03-016-272-I58













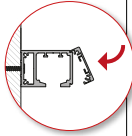
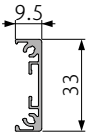

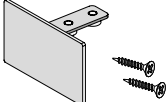
# opk Spaceship 80 W/G

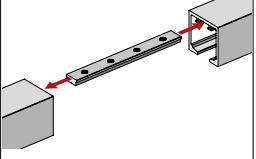
## Wandmontage

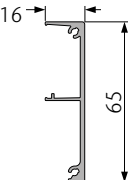
Wall Mounting / Montage mural

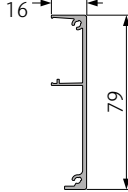
## Schienen, Zubehör

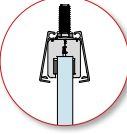
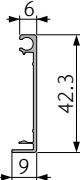
Tracks, Accessories / Rails, Accessoires

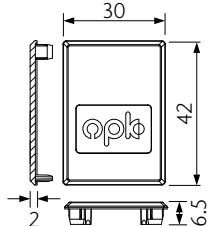
Produktbeschreibung Product description / Description du produit	Material Material / Matériel	Farbe Finish / Couleur	Länge (mm) Length / Longueur	Art.-Nr./No./ N° d'art.
<b>Blende 33mm</b> Decorative cover / Cache   	<b>Aluminium eloxiert</b> Anodized aluminium Aluminium anodisé	<b>Silber</b> Silver Argent	2500	03-016-25C-025
<b>Endkappe 47x33 mm</b> Endcap 47x33 mm / Embout 47x33 mm  	<b>Aluminium</b> Aluminium Aluminium	<b>Roh</b> Raw Brut	1 Paar/2 Stück 1 set/2 pcs 1 set/2 pcs	03-016-34D-002
<b>Verbinder Laufschiene</b> Connecting bracket / Connecteur de rails  	<b>Aluminium</b> Aluminium Aluminium	<b>Roh</b> Raw Brut	100	03-015-000-400
<b>Blende 65mm</b> Decorative cover / Cache  	<b>Aluminium eloxiert</b> Anodized aluminium Aluminium anodisé	<b>Silber</b> Silver Argent	2050 2500 3500 5800	03-016-25A-020 03-016-25A-025 03-016-25A-035 03-016-25A-058
<b>Blende 79mm</b> Decorative cover / Cache  	<b>Aluminium eloxiert</b> Anodized aluminium Aluminium anodisé	<b>Silber</b> Silver Argent	2050 2500 3500 5800	03-016-25B-020 03-016-25B-025 03-016-25B-035 03-016-25B-058
<b>Blende Glasklemmschuh</b> cover glass clamp / Cache cosse de serrage verre   	<b>Aluminium eloxiert</b> Anodized aluminium Aluminium anodisé	<b>Silber</b> Silver Argent	2500	03-016-25D-025
<b>Endkappe Glasklemmschuh</b> coverup glass clamp / Embout cosse de serrage verre   	<b>Kunststoff</b> Plastic Plastique	<b>Silber</b> Silver Argent	2 Stück 2 piece 2 pièces	03-016-34D-003

**Bausysteme**  
 Building systems /  
 Systèmes de construction

# opk Spaceship 80











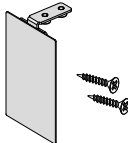

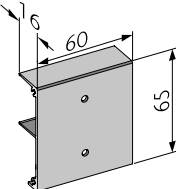
## Wandmontage

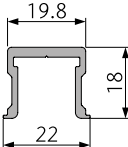
Wall Mounting / Montage mural

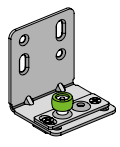

## Schienen, Zubehör

Tracks, Accessories / Rails, Accessoires

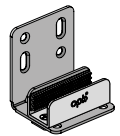
Produktbeschreibung Product description / Description du produit		Material Material / Matériel	Farbe Finish / Couleur	Länge (mm) Length / Longueur	Art.-Nr./No./ N° d'art.
<b>Endkappe 37x79 mm</b> Endcup 37x79 mm / Embout 37x79 mm 		<b>Aluminium</b> Aluminium Aluminium	<b>Roh</b> Raw Brut	1 Paar/2 Stück 1 set/2 pcs 1 set/2 pcs	03-016-25B-000
<b>Halterung Holzblende</b> Bracket wood cover / Couvercle en bois de support 		<b>Aluminium eloxiert</b> Anodized aluminium Aluminium anodisé	<b>Silber</b> Silver Argent	60	03-016-25D-000
<b>Führungsschiene Holz</b> Guiding track wood / Rail de guidage bois 		<b>Aluminium</b> Aluminium Aluminium	<b>Roh</b> Raw Brut	1250  2500	03-017-100-012  03-017-100-025
<b>Abdeckkappe für Führungsschiene</b> Cover cap guiding track / Embout rail de guidage 		<b>Kunststoff</b> Plastic Plastique	<b>Schwarz</b> Black Noir	1 Paar/2 Stück 1 set/2 pcs 1 set/2 pcs	03-017-170-000
<b>Wandmontagewinkel</b> Wall mounting angle / Angle de montage mural 		<b>Edelstahl</b> Stainless steel Acier inoxydable	<b>Silber</b> Silver Argent	1 Satz/ 1 set/ 1 set	03-015-000-300
<b>Wandwinkel mit Bodenführung Holz</b> Wall bracket with wooden floor guide / Équerre mural avec guidage au sol bois 		<b>Edelstahl</b> Stainless steel Acier inoxydable	<b>Silber</b> Silver Argent	1 Satz/ 1 set/ 1 set	03-013-101-000
<b>Wandwinkel mit Bodenführung Glas incl. Fleece</b> Wall bracket with floor guide glass incl. Fleece / Équerre mural avec guidage au sol verre 		<b>Edelstahl</b> Stainless steel Acier inoxydable	<b>Silber</b> Silver Argent	1 Satz/ 1 set/ 1 set	03-013-301-000

# opk Spaceship 80

## Wandmontage

Wall Mounting / Montage mural



## Schienen, Zubehör

Tracks, Accessories / Rails, Accessoires

Produktbeschreibung Product description / Description du produit		Material Material / Matériel	Farbe Finish / Couleur	Länge (mm) Length / Longueur	Art.-Nr./No./ N° d'art.
<b>Endkappe Laufschiene</b> Cover cup running track / Embout rail de roulement  	33x33mm  	<b>Kunststoff</b> Plastic Plastique	<b>Schwarz</b> Black Noir	1 Paar/2 Stück 1 set/2 pcs 1 set/2 pcs	03-016-30C-E00
			<b>Silber</b> Silver Argent	1 Paar/2 Stück 1 set/2 pcs 1 set/2 pcs	03-016-34C-E00
<b>Endkappe Laufschiene</b> Cover cup running track / Embout rail de roulement  	47x65mm  	<b>Kunststoff</b> Plastic Plastique	<b>Schwarz</b> Black Noir	1 Paar/2 Stück 1 set/2 pcs 1 set/2 pcs	03-016-30A-A00
			<b>Silber</b> Silver Argent	1 Paar/2 Stück 1 set/2 pcs 1 set/2 pcs	03-016-34A-A00
<b>Endkappe Laufschiene</b> Cover cup running track / Embout rail de roulement  	47x79mm  	<b>Kunststoff</b> Plastic Plastique	<b>Schwarz</b> Black Noir	1 Paar/2 Stück 1 set/2 pcs 1 set/2 pcs	03-016-30B-A00
			<b>Silber</b> Silver Argent	1 Paar/2 Stück 1 set/2 pcs 1 set/2 pcs	03-016-34B-A00
<b>Endkappe Laufschiene</b> Cover cup running track / Embout rail de roulement  	53x65mm  	<b>Kunststoff</b> Plastic Plastique	<b>Schwarz</b> Black Noir	1 Paar/2 Stück 1 set/2 pcs 1 set/2 pcs	03-016-30A-B00
			<b>Silber</b> Silver Argent	1 Paar/2 Stück 1 set/2 pcs 1 set/2 pcs	03-016-34A-B00
<b>Endkappe Laufschiene</b> Cover cup running track / Embout rail de roulement  	53x79mm  	<b>Kunststoff</b> Plastic Plastique	<b>Schwarz</b> Black Noir	1 Paar/2 Stück 1 set/2 pcs 1 set/2 pcs	03-016-30B-B00
			<b>Silber</b> Silver Argent	1 Paar/2 Stück 1 set/2 pcs 1 set/2 pcs	03-016-34B-B00
<b>Endkappe Laufschiene</b> Cover cup running track / Embout rail de roulement  	59x65mm  	<b>Kunststoff</b> Plastic Plastique	<b>Schwarz</b> Black Noir	1 Paar/2 Stück 1 set/2 pcs 1 set/2 pcs	03-016-30A-C00
			<b>Silber</b> Silver Argent	1 Paar/2 Stück 1 set/2 pcs 1 set/2 pcs	03-016-34A-C00
<b>Führungsschwert unten</b> Guiding sword floor bottom / Guide épée en bas  	5x44mm  	<b>Kunststoff</b> Plastic Plastique	<b>Schwarz</b> Black Noir	1 Stück 1 pcs 1 pcs	03-013-100-000

**Bausysteme**  
 Building systems /  
 Systèmes de construction

# opk Spaceship 80

## Magnetische Führung

Magnetic Locator / Guidage magnétique



### Schienen, Zubehör

Tracks, Accessories / Rails, Accessoires

Produktbeschreibung Product description / Description du produit		Material Material / Matériel	Farbe Finish / Couleur	Länge (mm) Length / Longueur	Art.-Nr./No./ N° d'art.
<p><b>Magnetische Führung</b> Magnetic Locator / Guidage magnétique</p> <p><b>Magnetstift Türteil</b> Magnetic pin door part / Pièce de porte à goupille magnétique</p> <p><b>Magnetstift unten</b> Magnetic pin bottom / Goupille magnétique en bas</p> 	  	<p><b>Metall/ Kunststoff</b> Metal / Plastic Métal / Plastique</p>	<p><b>Silber/ Schwarz</b> Silver / Black Argent / Noir</p>	<p>1 Satz/ 1 set/ 1 set</p>	03-013-000-000

## Montageanleitung für Holztür

Mounting Instruction for Wood Door /

Instructions de montage pour porte en bois

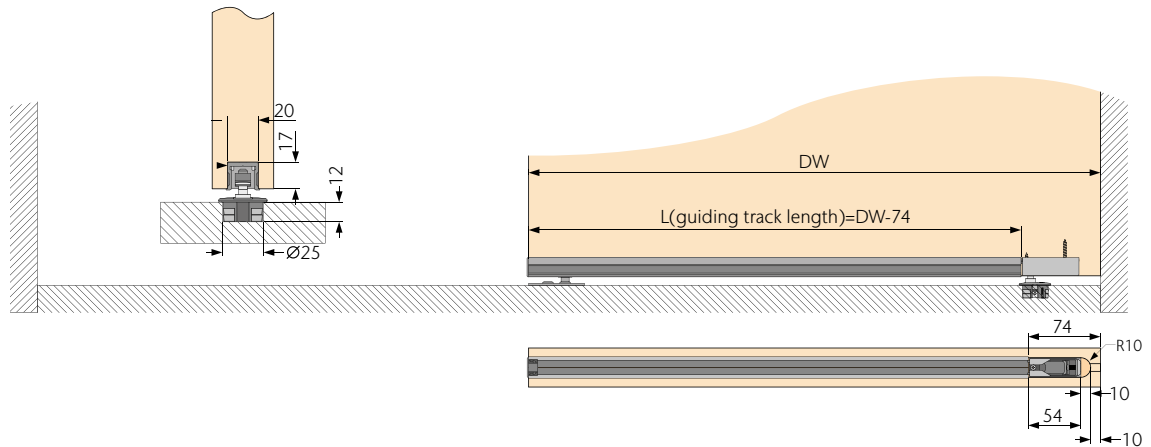

### Installieren der oberen magnetischen Führung

Install magnetic upper guide / Installer Guidage magnétique en haut

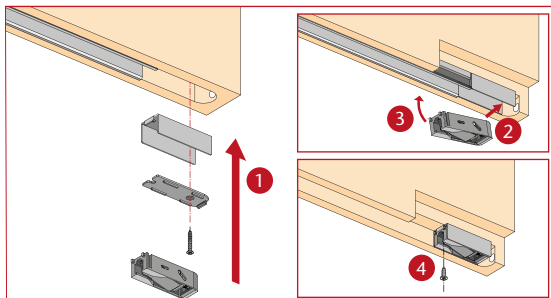

### Installieren der unteren magnetischen Führung

Install magnetic bottom guide / Installer Guidage magnétique en bas

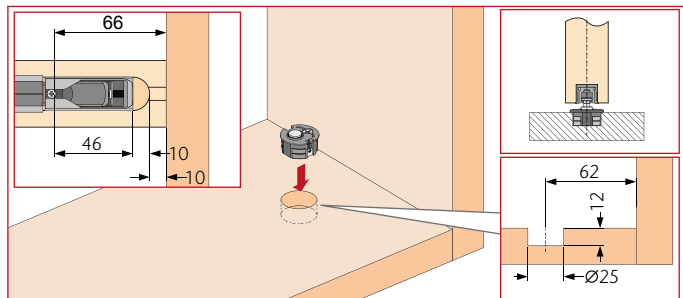



# opk SPACESHIP 80

