

Door width calculation/Türbreitenberechnung

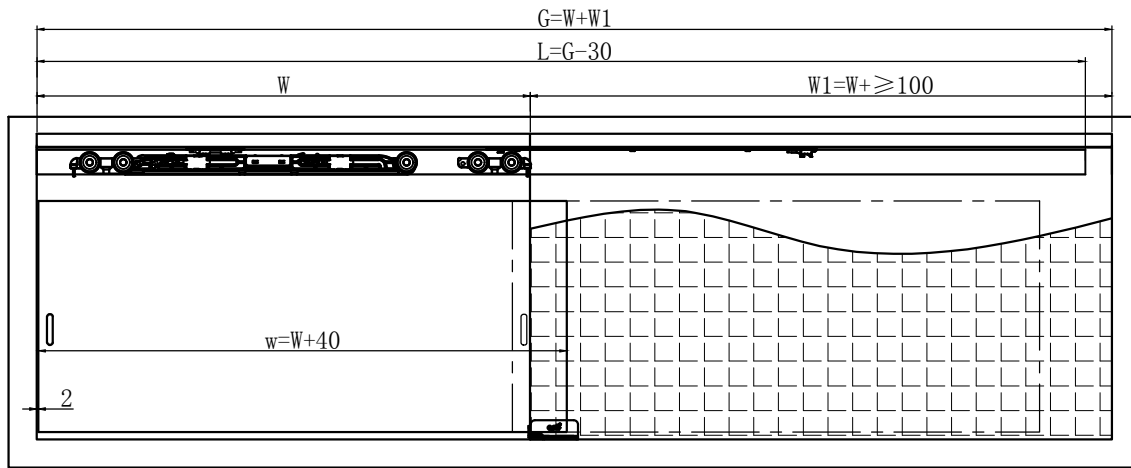

Installation instruction/Einbau Anleitung

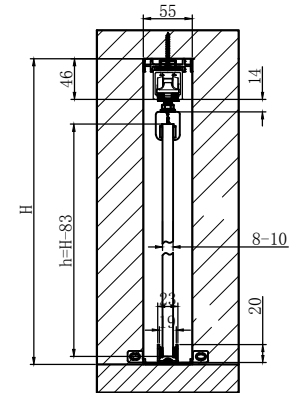

Door panel processing parameters/Tür Bearbeitungsparameter

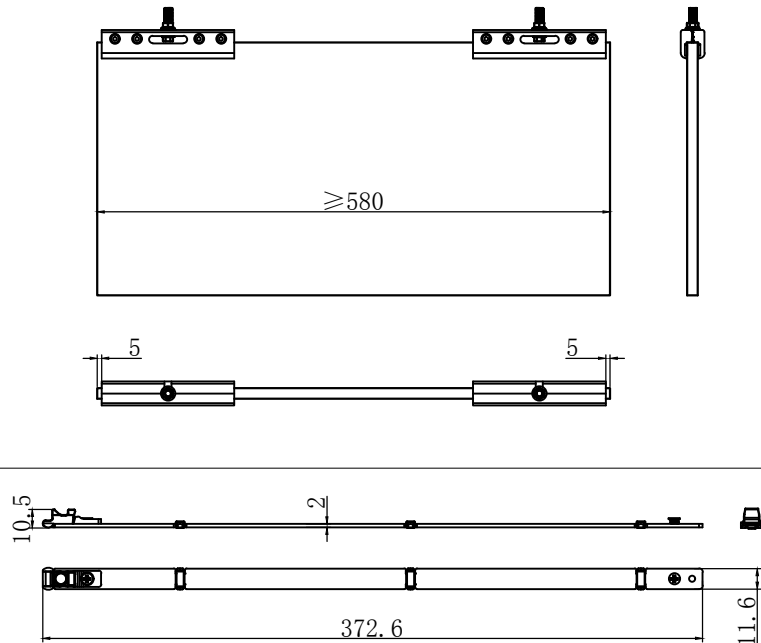

Running part with two-way damper/Laufwerk 2-Wege Dämpfer

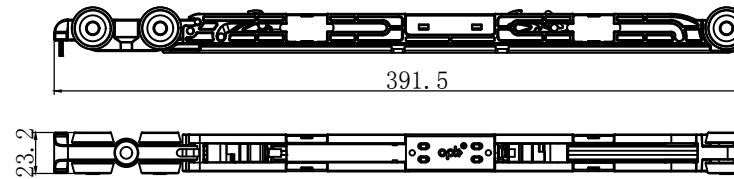

Running part(roller)/Laufwerk

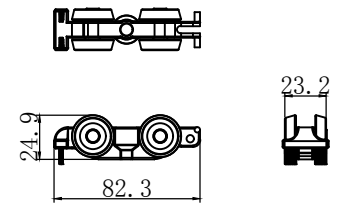

Glass clamp/Klemmschuh Glas 8+10 mm

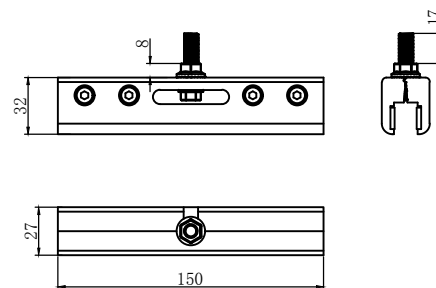

Activator/Aktivator

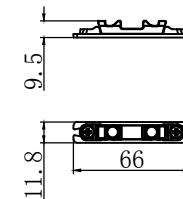

Floor guide glass incl.fleece /Bodenführung Glas inkl.Filz

